



ASSEMBLY MANUAL











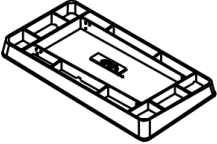











JETT POWER FLO STRIKER

840410

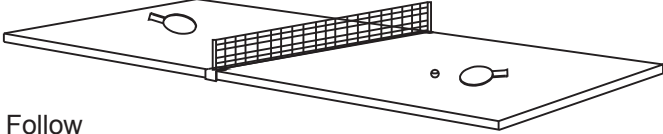
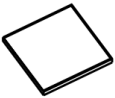

ASSEMBLY MANUAL

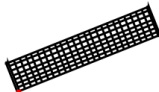
Part List

<p>#1</p>  <p>Playfield-Hockey Table 1 pc</p>	<p>#2</p>  <p>Left leg 2 pcs</p>	<p>#3</p>  <p>Right leg 2 pcs</p>	<p>#4</p>  <p>Leg connect board 2 pcs</p>	<p>#5</p>  <p>Leg levellers 4 pcs</p>
<p> Shaded box=pre-installed part</p>				
<p>#31</p>  <p>Battery box 1 pc</p>	<p>#32</p>  <p>Puck catcher wire 2 set</p>	<p>#33</p>  <p>Led Scoring 1set</p>	<p>#34</p>  <p>Scorer base box 1 pc</p>	<p>#6</p>  <p>5/16"X45mm Bolts 12 pcs</p>
<p>#7</p>  <p>T4X1" Screws 12 pcs</p>	<p>#8</p>  <p>5/16" Washers 12 pcs</p>	<p>#9</p>  <p>Tool 1 pc</p>	<p>#10</p>  <p>Puck 2 pcs</p>	<p>#11</p>  <p>Striker 2 pcs</p>
<p>#12</p>  <p>Felt pad 2 pcs</p>	<p>Optional Addition: Table Tennis Conversion Top - Item# 840411</p>  <p>Table Top Parts Follow</p>			<p>#13</p>  <p>Table tennis table 2 pcs</p>
<p>#14</p>  <p>Wood plug 2 pcs</p>	<p>#15</p>  <p>Table tennis balls 2 pcs</p>	<p>#16</p>  <p>Table tennis bats 2 pcs</p>	<p>#17</p>  <p>Table tennis nets 1 pc</p>	<p>#18</p>  <p>Table tennis net clamp 2 pcs</p>

STEP 1

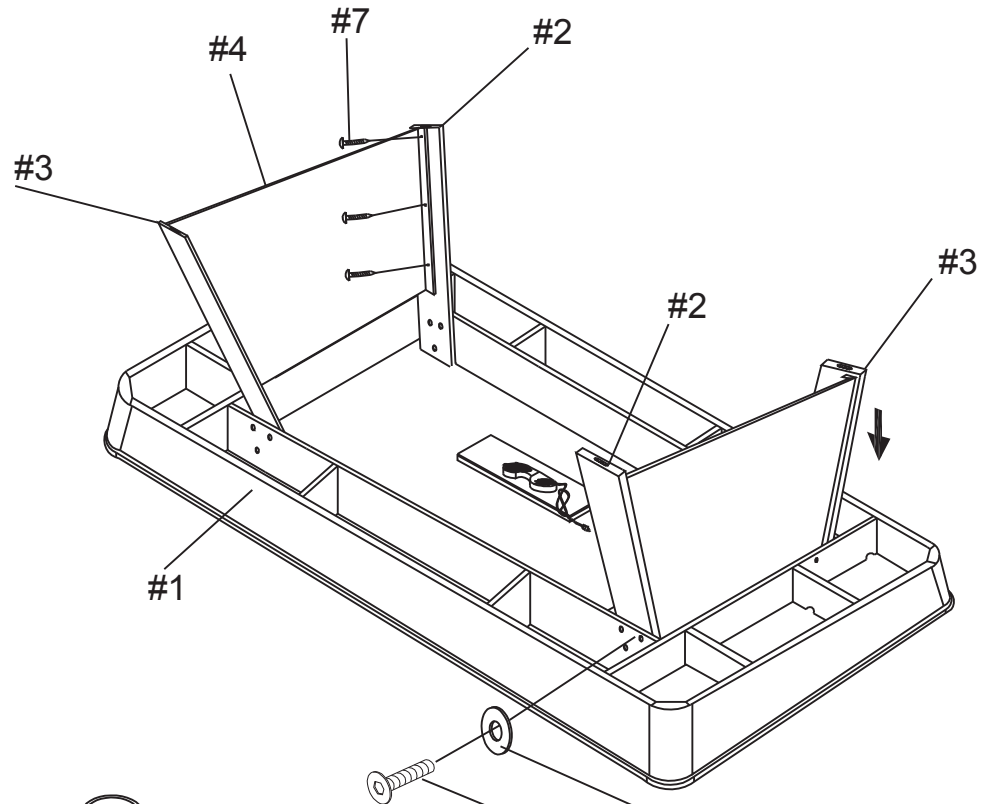

STEP 2

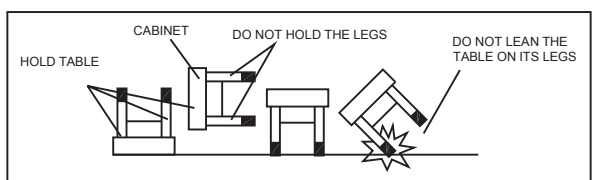
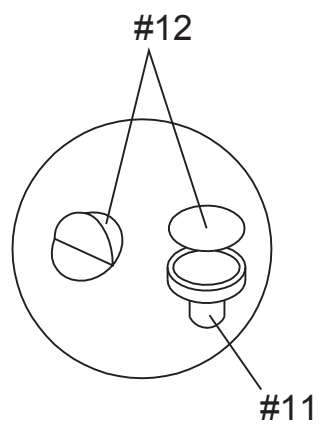
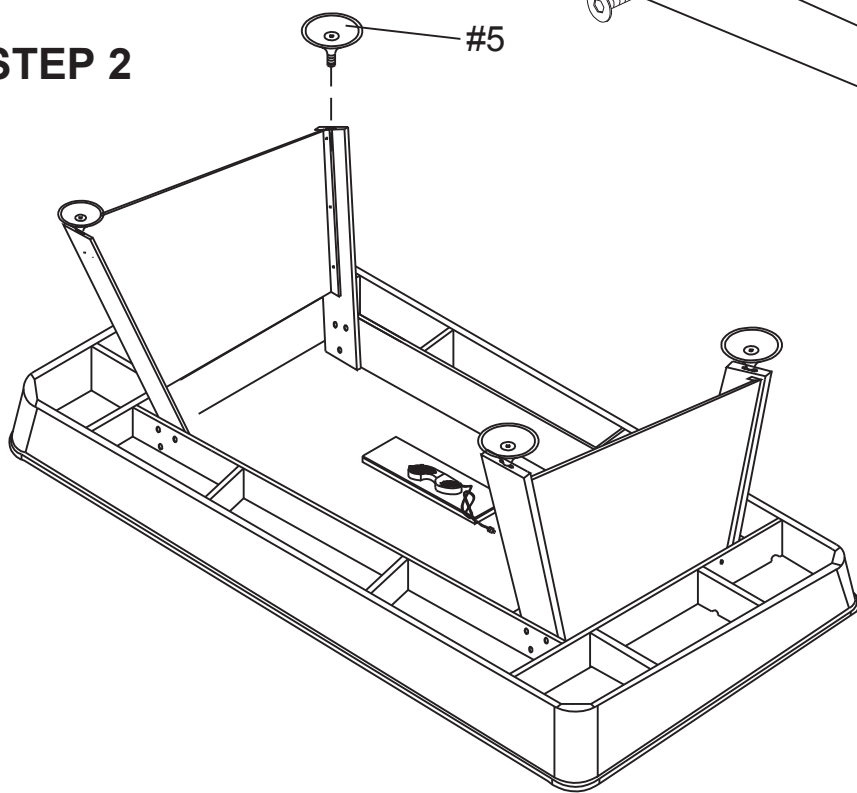

**IF YOU HAVE PURCHASED THE TENNIS TABLE CONVERSION TOP
ITEM#: 840411**

STEP 3

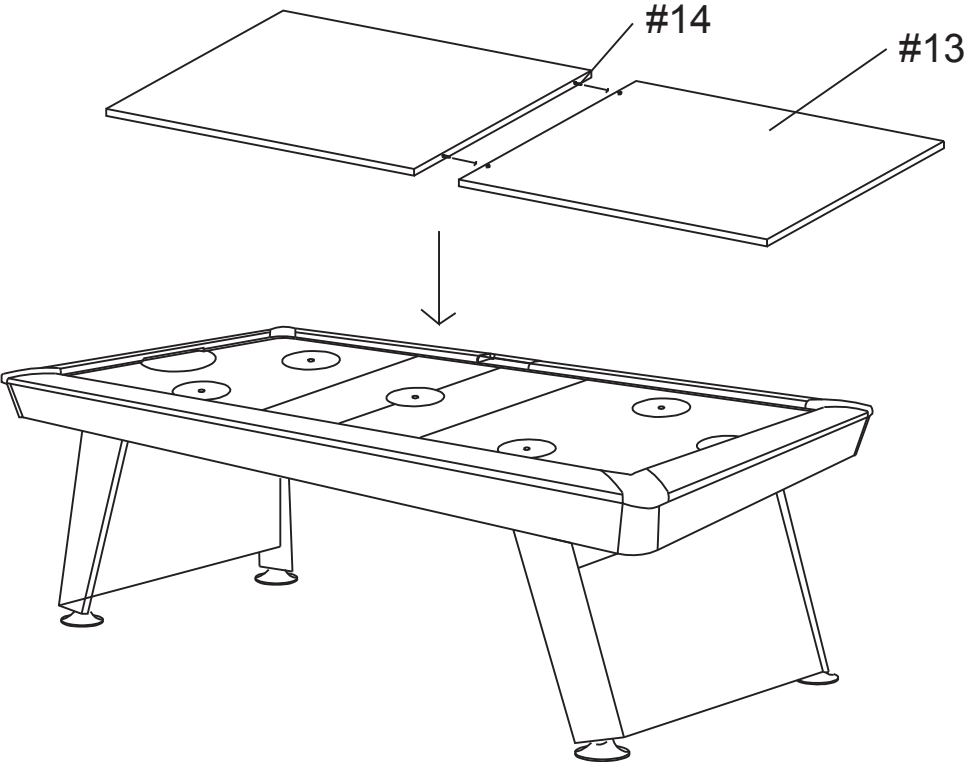

STEP 4

