

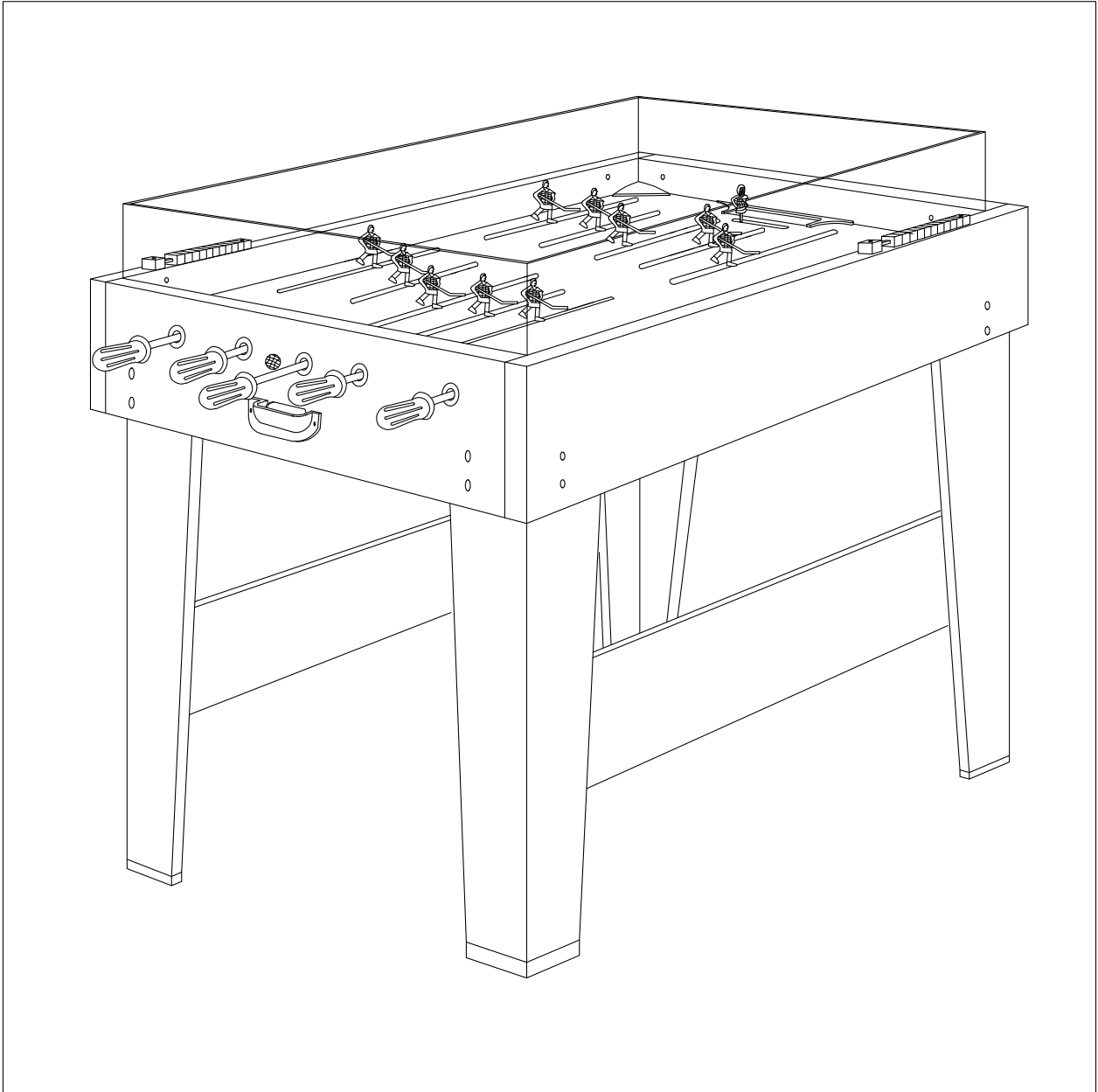

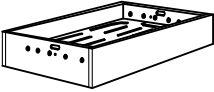

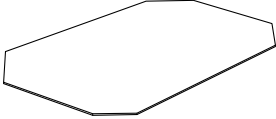





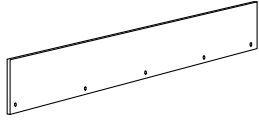
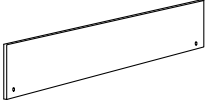
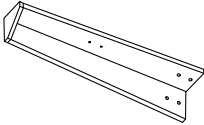
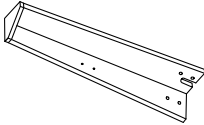
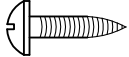
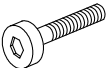

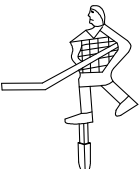
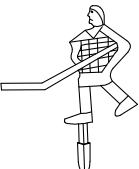

# ROD HOCKEY

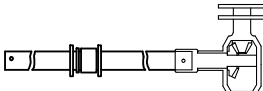
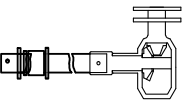
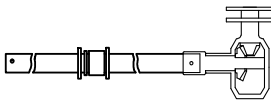
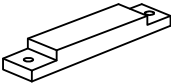



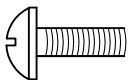



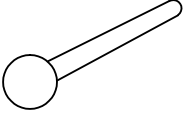

**ITEM NO. 840207**

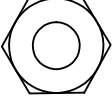
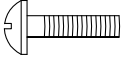
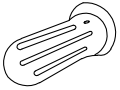
# Parts List for

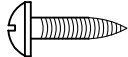
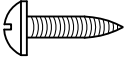
<p><b>#1</b></p>  <p><b>Cabinet 1 piece</b></p>	<p><b>#2</b></p>  <p><b>Board 1 piece</b></p>	<p><b>#3</b></p>  <p><b>Leg side panel 2 pieces</b></p>	<p><b>#4</b></p>  <p><b>Plastic wall A 2 pieces</b></p>
<p><b>#5</b></p>  <p><b>Plastic wall B 2 pieces</b></p>	<p><b>#6</b></p>  <p><b>Left leg 2 pieces</b></p>	<p><b>#7</b></p>  <p><b>Right leg 2 pieces</b></p>	<p><b>#8</b></p>  <p><b>T4X1/2" Screw 32 pieces</b></p>
<p><b>#9</b></p>  <p><b>5/16"X1-1/4" Bolt 16 pieces</b></p>	<p><b>#10</b></p>  <p><b>5/16" Washer 16 pieces</b></p>	<p><b>#11</b></p>  <p><b>Plastic washer 6 pieces</b></p>	<p><b>#12</b></p>  <p><b>Blue goalies 1 piece</b></p>
<p><b>#13</b></p>  <p><b>Blue players 5 pieces</b></p>	<p><b>#14</b></p>  <p><b>Red players 5 pieces</b></p>	<p><b>#15</b></p>  <p><b>Red goalies 1 piece</b></p>	<p><b>#16</b></p>  <p><b>Medium player rod 2 pieces</b></p>
<p><b>#17</b></p>  <p><b>Short player rod 4 pieces</b></p>	<p><b>#18</b></p>  <p><b>Long player rod 4 pieces</b></p>	<p><b>#19</b></p>  <p><b>10 pieces</b></p>	<p><b>#20</b></p>  <p><b>Puck catcher 2 pieces</b></p>
<p><b>#21</b></p>  <p><b>Goal A 2 pieces</b></p>	<p><b>#22</b></p>  <p><b>Goal B 2 pieces</b></p>	<p><b>#23</b></p>  <p><b>4X1/2" Bolt 2 pieces</b></p>	<p><b>#24</b></p>  <p><b>4X13mm Washer 2 pieces</b></p>

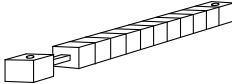
## Parts List Continued

<p><b>#25</b></p>  <p><b>Goalie control knob 2 pieces</b></p>	<p><b>#26</b></p>  <p><b>Spring 10 pieces</b></p>	<p><b>#27</b></p>  <p><b>3mm Nut 10 pieces</b></p>	<p><b>#28</b></p>  <p><b>3X25mm Screw 10 pieces</b></p>
<p><b>#29</b></p>  <p><b>Rod handle 10 pieces</b></p>	<p><b>#30</b></p>  <p><b>Allen wrench 1 piece</b></p>	<p><b>#31</b></p>  <p><b>Plastic wall post 4 piece</b></p>	<p><b>#32</b></p>  <p><b>T3X5/8" Screw 8 pieces</b></p>
<p><b>#33</b></p>  <p><b>T4X3/4" Screw 14 pieces</b></p>	<p><b>#34</b></p>  <p><b>F4X1-1/2" Screw 4 pieces</b></p>	<p><b>#35</b></p>  <p><b>Slide scorer 2 pieces</b></p>	<p><b>#36</b></p>  <p><b>Puck 2 pieces</b></p>

## Step 1:

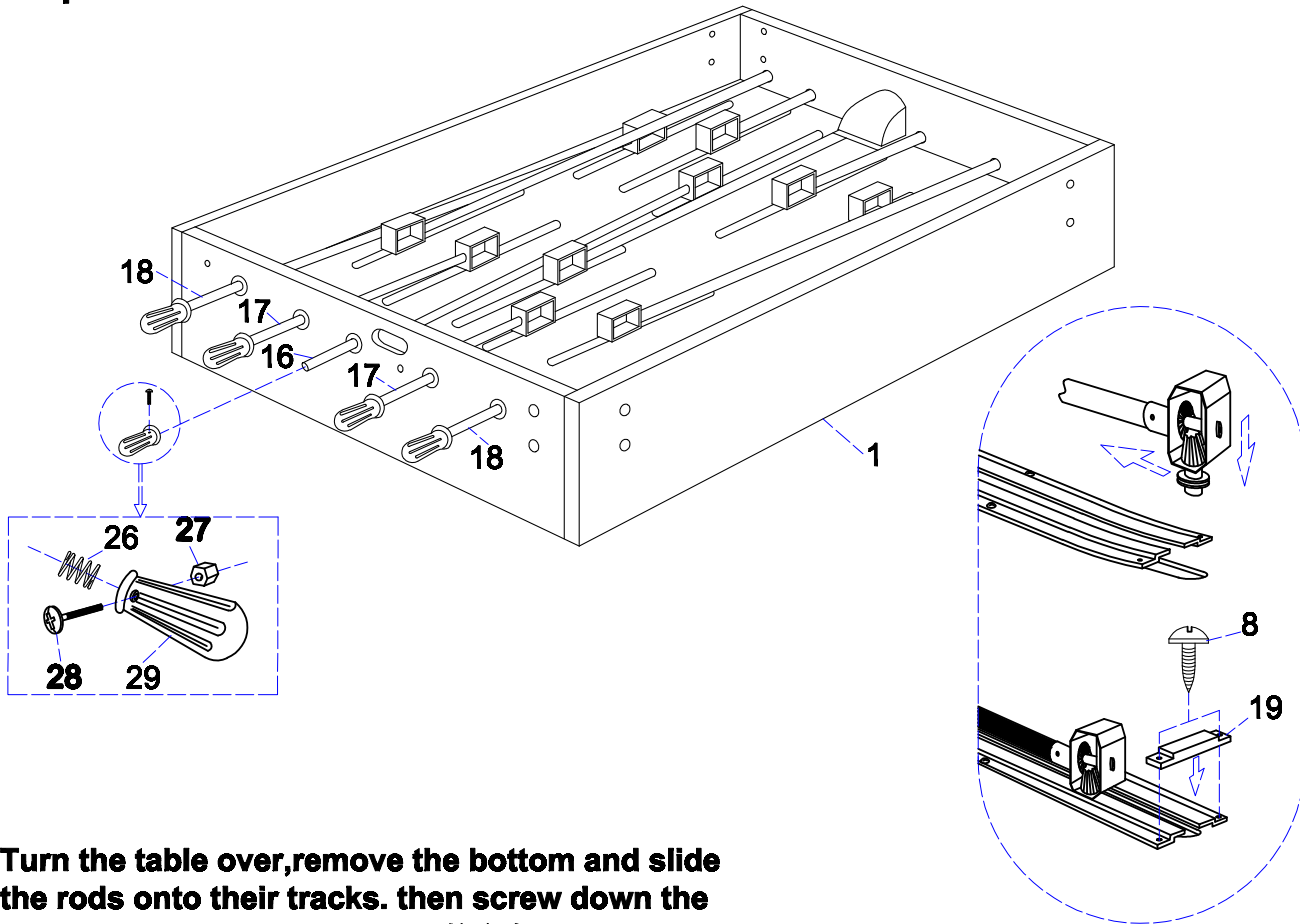

Turn the table over, remove the bottom and slide the rods onto their tracks. then screw down the end caps to secure the tracks(9,37).

Then add the handles by sliding on a spring to the rod, sliding on the handle and bolting them to the rod(5,29,26,4).

## Step 2:

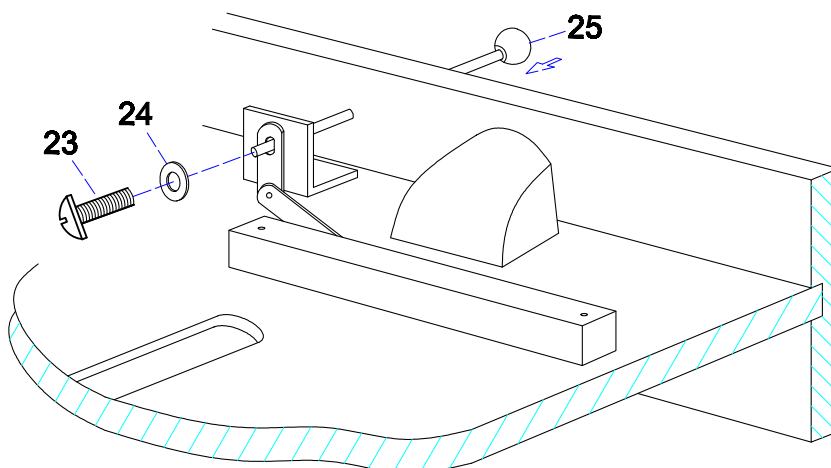

**Step 3:**

**Attach the legs as shown.**

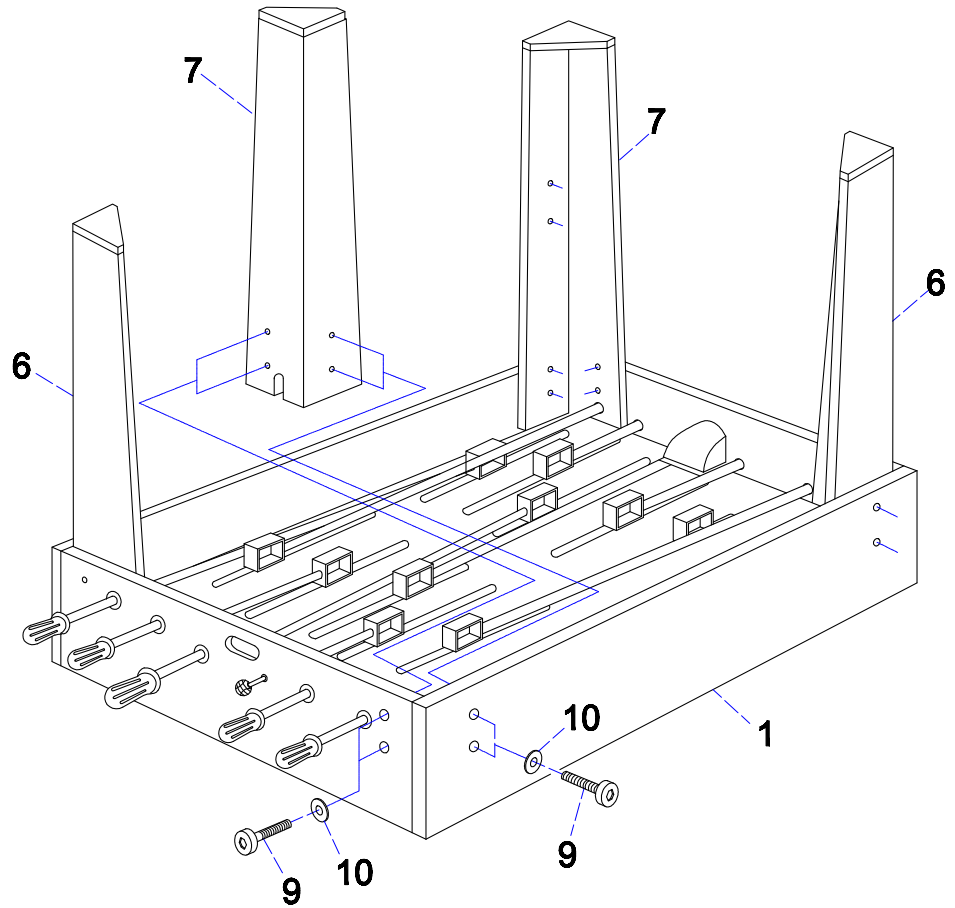

**Step 4:**

**Attach the base and stabilizing boards as shown.**

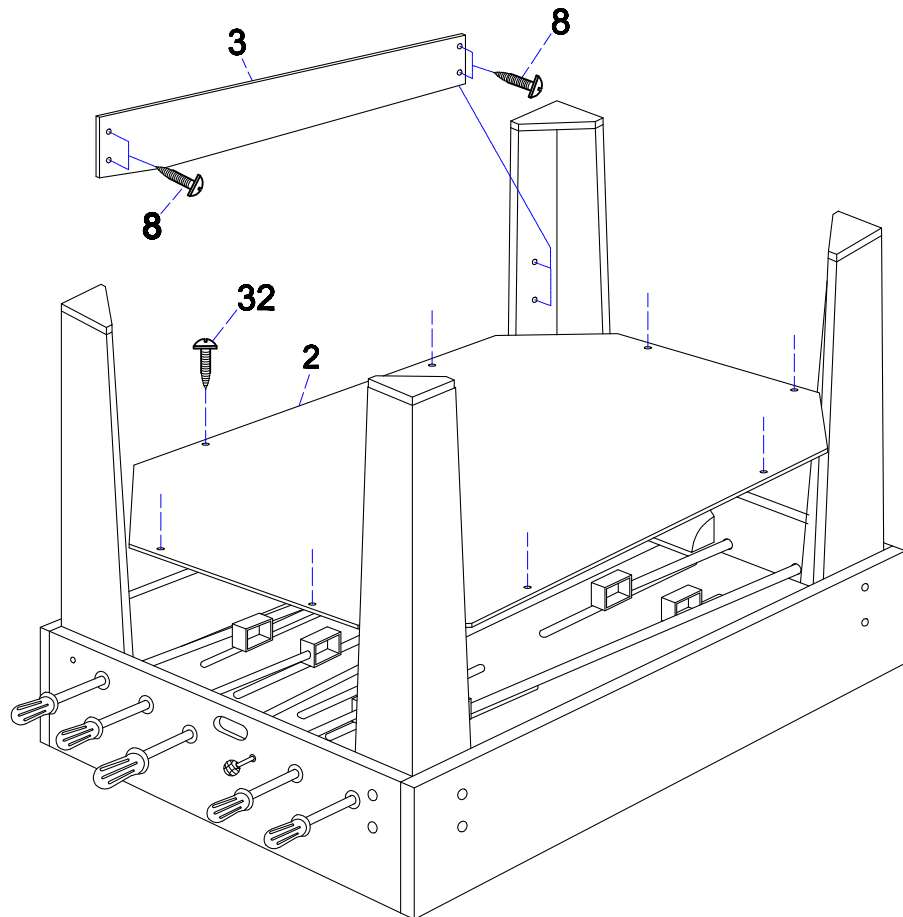

## Step 5:

Take the four plexi-side boards with the corner posts and affix to the table. Add the goal/puck catchers with screw(9) as shown.

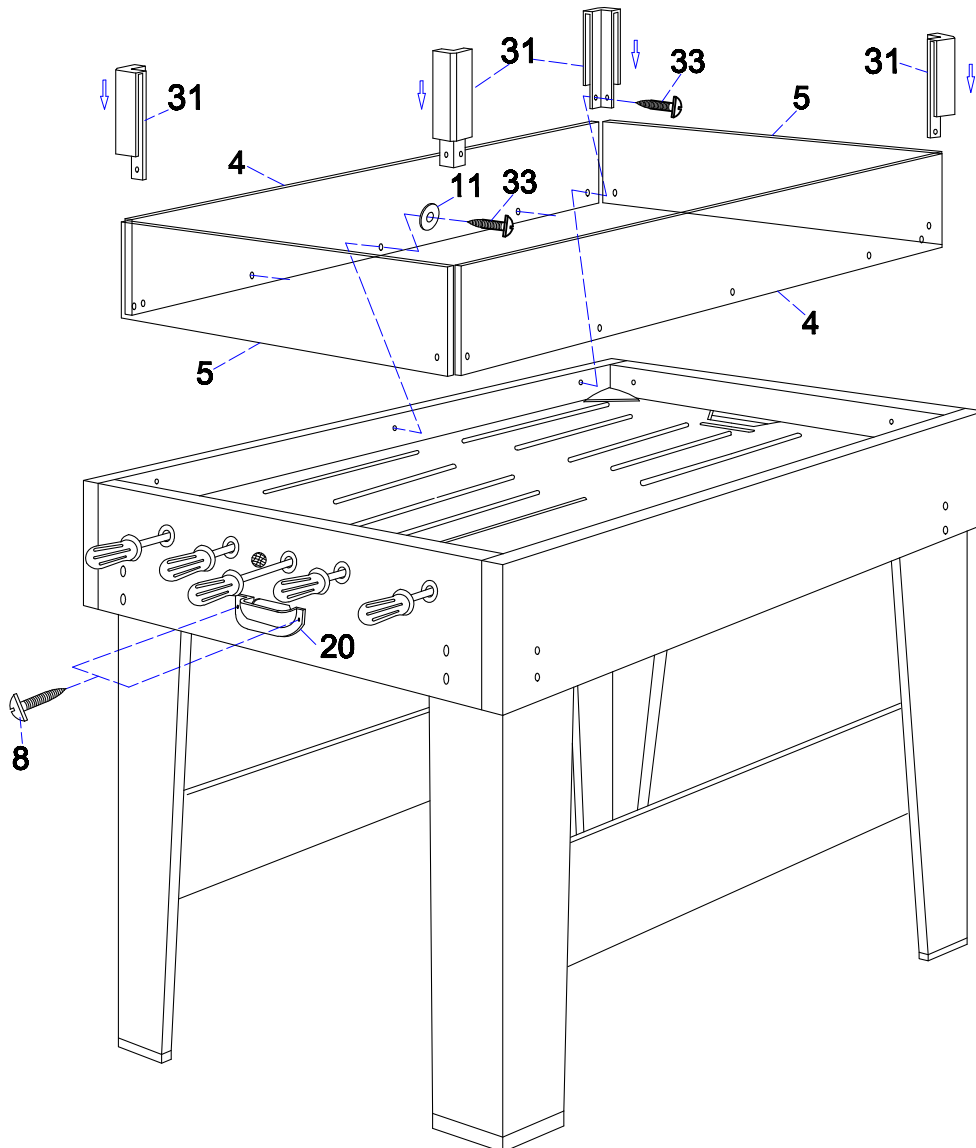

**Step 6:**

Place the goals in the post holes and add the spacers to keep the puck in play.

Then screw on the scorers to the top side of table.

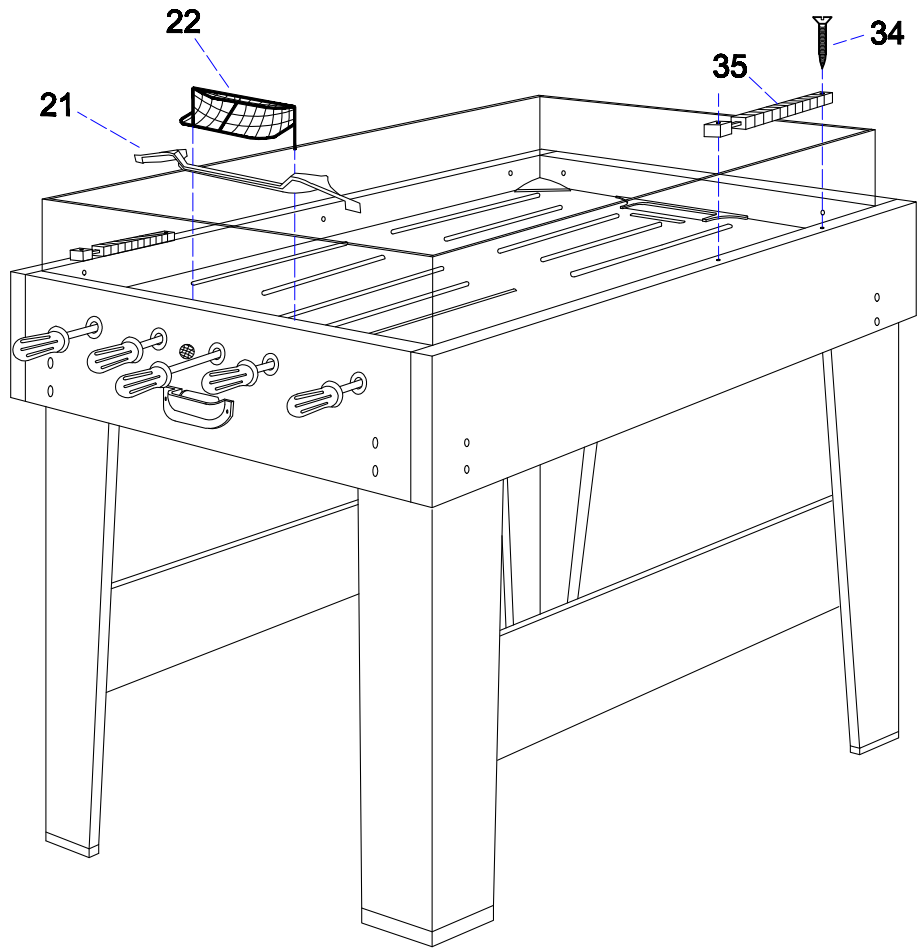

**Step 7:**

Add the players.

